

# COMBINED DOORPHONE

**KDP-602A/D MANUAL FOR OPERATION AND INSTALLATION**

KOCOM CO.,LTD.

### Features

- Can be used with direct interphone and doorphone
- Differentiated call signal to rooms and door station
- Used : home,office,apartment,factory,hospital etc.
- Can be combined with door opener.
- Can be used 1:1interphone

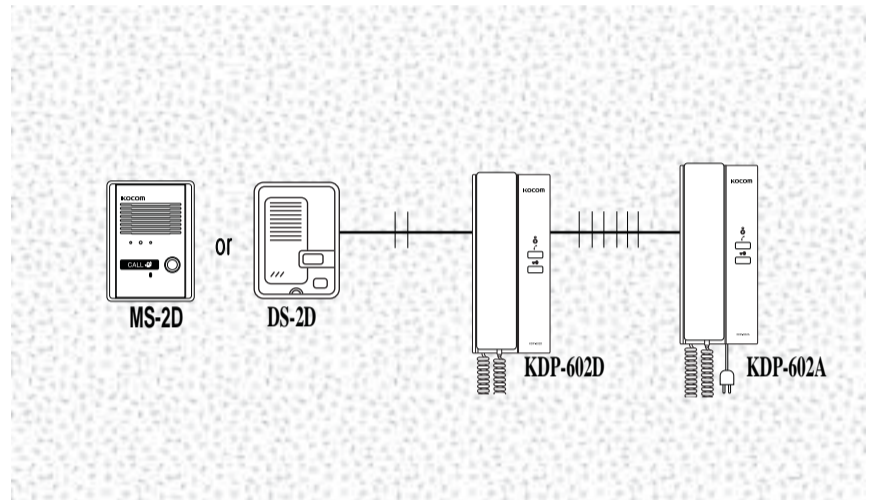

KDP-602A/D P1112



KOCOM CO.,LTD.

## Cautions for safety

For safe use, please stick to the following cautions.

- Please, save this manual after reading these instructions carefully. Read and understand all instructions to set up rightly.
- This Cautions for Safety may include items that are not contained in specifications of the product that consumer purchases.
- If you need assistance with the set-up or operation, please contact with A/S center.

### The important marks in the manual.

To help our customers to understand this manual, to prevent any personal injury or property damage, some marks are used in the manual. The marks and the drawing signs are below. Please, understand the marks before reading the manual.

### The meaning of the drawing signs.

Sign to show what not to do	Mishandling the device with ignoring this sign may result in serious injury or death.
Mishandling the device with ignoring this sign may result physical injury or material damage.	
Sign to tell you that you should follow the instructions.	Sing to tell you that you need more attention including high voltages, electric shock, danger, warning)
Sign to tell you that you can't disassemble this unit.	Sign to tell you that you must unplug the unit.

## Caution

### Cautions for set-up

- The law limits distributing the power lines to an authorized person from government. The work from an unauthorized person cause fire or electric shock.
- Place this unit securely on a stable surface. Serious damage and/or injury may result if the unit falls.
- Do not set up this unit near the leaking place because it may expose you to dangerous voltages or other risks.
- Even if your product is water proof, do not install it slanted place of water leakage, which can a short circuit.
- The work of distributing wires needs skills and experiences. So please, for assistance, contact your dealer or call service center.
- The communication lines should be built in being distant from the power source. This may result in the risk of fire, electric shock and communication disorder.
- Setting the communication lines in a high humid place such as outside without any protection from rain causes the communication disorder.
- Keep the hook at the wall-mounted device safe. The hook may cause the physical injury.
- Think about the thickness and quality of wall material. The unqualified material may make the device fall.
- Set the device of the wall-mounted type not to fall. Falling from an earthquake causes personal injury.

### Cautions for Repairs and Maintenance

- Keep the inside of the device clean. Having the dust inside without any cleaning for a long time causes the fire. If necessary, contact your dealer or service center to get cleaning service.
- Unplug this device when you want to check the inside. If there is no plug, please, turn off the circuit breaker.
- Unplug this device when you try to move it to another place. If the electric line is connected inside of the unit, please contact your dealer or service center.
- Do not use liquid or aerosol cleaners. Use a damp cloth for cleaning

## Warning

### Warnings for Usage

- Do not install this unit near the water and dust, for example, in a bathroom or near the washing machine. It caused fire and electric shock.
- Do not install this unit near the fire, for example, near kitchen sink, heater or the like.
- Do not install near the noxious gas such as Hydrogen Sulfide, metal power and the like.
- Do not install near the water and chemicals.
- Do not give any damage, break and modify the plug. Overloading, heating, pulling causes the damage.
- Do not place the plug near the heater. The damaged code causes fire and electric shock. Do not pull the power code when unplugging.
- The damaged code causes fire and electric shock. Must pull with plug. Do not touch with wet hands, it causes the electric shock.
- Do not use any other voltage, except the marked regular voltage.
- Do not use the power terminal at the units to other electric device except the designed device.
- Do not install the units at the leaking place if it doesn't have any waterproof mark. Do not install the unit when the power is on.
- Install the circuit breaker after checking the safety such as electric shock and leakage. Turn off the power before you install or A/S

- Check the suitability of the lines for installing when you use the exiting lines.
- Do the wiring work by using the designed material.
- Connect the electric wire with the designed ways and ground.
- Do not connect with any other devices except the designed devices to compose the system.
- Unplug electric wire and communication lines from the units before moving to another place.

### Cautions for Use

- This unit is not designed for security purpose. Do not handle the unit with the wet hands.
- Do not place a pot with water or a small metal material on the Units.
- Do not cover the ventilating opening or put any metal material in the units.
- During thunderstorms, avoid using this unit. There may be a remote risk of an electric shock from lightning.
- Do not modify the unit. Open the main gate after checking ID if the image and sound system do not work. Call A/S

### Cautions for Abnormality

- Change the damaged electric code.
- Unplug this unit from plug socket and refer servicing to an authorized service center when the following conditions occur:
  - If liquid has been spilled into the unit.
  - If the unit does not work normally by following the operating instructions.
  - If the unit exhibits a distinct change in performance.
  - If the unit has been dropped or physically damaged.

## Caution

### Safety Instructions, Warnings and Cautions of Each System

- Do not disassemble this unit as will as this device is composed by precision parts. Install the unit by following the set-up instructions of Kocom.
- Do not touch or insert any foreign substances, for example, sticker, magnetic, opener and the like
- Make U-type at the end of wires as the rain can effect on the system by following the wires during the rainy season.

### Videophone

- Separate the AC/DC lines with the hook of the wall-mounted type when installing. Connect the lines after peeling the wires properly
- Do not distribute signal line with AC line. Use the designed driver to connect the lines to terminal
- Do not clean the LCD with the damp cloth for cleaning. Use the only dry and soft cloth. Do not install the main gate monitor at the leaking place.

### Things You Need to Know

- This product is designed as a home videophone and cannot use continuously like monitor camera.
- If there is temperature difference between inner part of camera and surrounding, dew condensation occurs on camera lens and may disturb image. If dew condensation is removed from camera lens, image quality recovers.
- White LED light examination range is narrower than camera shot range at night, so there is less amount of light at night than day. So it is difficult to see the face in low illumination condition due to noise increase on screen, but it is not from defect.
- Monitor screen (liquid crystal panel) is not in defect when some pixels always light or black out.
- Please install monitor and camera over 5cm away. Also, avoid installing at a place with too much noise, because too much noise around camera causes phone call inferiority.
- Do not place an object within 20cm in front of monitor. It causes phone call inferiority, especially because microphone is installed at the top of monitor.
- If strong light such as sunlight flows into camera module, screen saturation (or strange mark) and image shaking might occur.
- This is not a defect, so please do not install camera where a direct ray of light do not flow if possible.

### Cautions

- In some cases there is occurrence of product destruction, malfunction, noise mixing and picture quality deterioration due to mixing of other tool's induced voltage or thunder with communication wiring of monitor/camera, monitor/extended monitor.
- Do not wire with power line such as outdoor wiring or AC power, or phones and other tools.
- You cannot use it if you incorrectly wire the AC voltage between monitor/camera, monitor/extended monitor. Call the store or agency where you purchased this product and consult to solve the problem.
- Beware that unfixable damage might be caused due to authorizing AC voltage on communication wiring of monitor/camera, monitor/extended monitor.
- Do not ever disjoint this product. It may cause electrocution accident when touching high-voltage circuit inside this product.
- Outside power authorizing this product must be confirmed of product description and use rated voltage. Beware that if higher voltage is authorized, unfixable damage might be caused due to product destruction.
- Power must be connected to domestic voltage (product rated voltage) consent or interior wiring.
- If connected to other motive power or inverter-type power, product destruction, noise mixing, and picture distortion may occur.
- Do not drop this product. Glass is used for monitor and might break, or cause other circuit inferiority.
- In such case, immediately turn down the power switch, and call to consult agency or store in which this product was purchased.
- If installed near transmission antenna such as broadcasting station, electric wave may mix and cause picture distortion or voice mixing.
- Avoid installing near tools with strong electromagnetic waves such as microwaves and cell phones, or it may cause picture distortion.
- Do not install monitor in following places.
  - Above or around water heater, rice-cooker, heater
  - Place exposed to direct rays of the sun
  - Place with temperature below 0°C such as cold store
  - Place with high humidity such as bathroom, washroom, heated room
  - Place with a lot of gas, dust, smoke
  - Dangerous place with sprays of water or chemicals
- Beware of occurrence of image quality deterioration or malfunction from cause of humidity due to penetration of chemicals or water into camera's urea resins.
- As in the picture, it prevents temperature difference of camera (outside) and monitor (inside), and removes dew condensation caused by humidity of camera window.
- Camera must be installed when wall cement is completely dry.
- When product is installed in winter below -5°C, wait for approximately 2 hours to connect. Dew formation in monitor and camera due to temperature difference inside and outside may cause product defect.
- Avoid installing monitor and camera in place directly exposed to heat or where gas noxiousness is highly occurring.
- Minimum distances around the apparatus for sufficient ventilation.
- The ventilation should not be impeded by covering the ventilation openings with items, such as newspapers, table-cloths, curtains, etc.;
- No naked flame sources, such as lighted candles, should be placed on the apparatus;
- The use of apparatus in tropical and/or moderate climates.
- The apparatus shall not be exposed to dripping or splashing and that no objects filled with liquids, such as vases, shall be placed on the apparatus.
- To prevent injury, this apparatus must be securely attached to the floor/wall in accordance with installation instructions.
- To completely disconnect this apparatus from the AC Mains, disconnect the power supply cord plug from the AC receptacle.

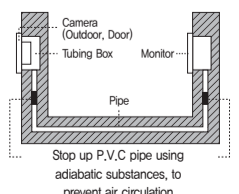

## How to operate (Instruction for operating)

### Doorphone function



When visitors push the outdoor station call button,

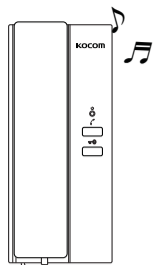

The indoor station 2pcs are ringing.

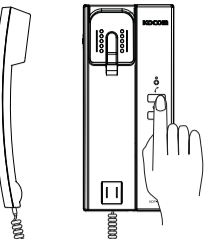

Pick up the handset, and push the "Door Key" button if you want to open the door.

### Interphone function

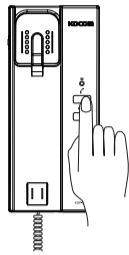

If you want to communicate with another indoor station, pick up the handset and push the "INT" button.

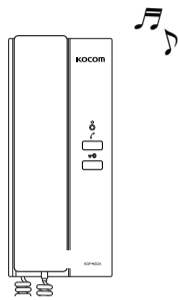

Another indoor station is ringing.

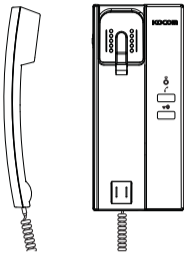

Pick up the handset, and you can communicate with another indoor station.

During communication between the outdoor station and the Interphone-1, if the interphone-1 wants to connect the interphone-2 with the outdoor station, push the hook button first and of Interphone-1 to page the interphone-2.

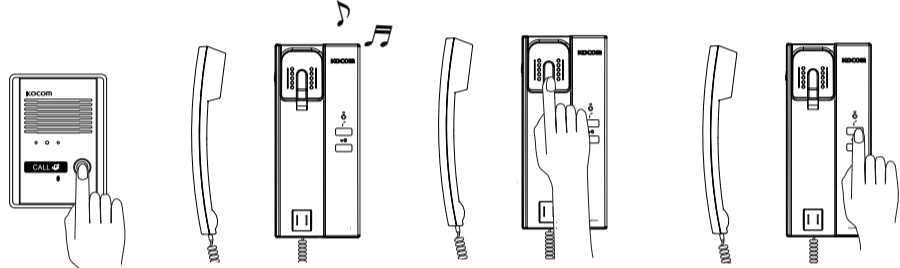

## Precautions for Operation

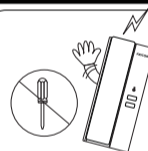

As this device consists of precise electronic components, and high voltage is generated internally, do not attempt to disassemble.

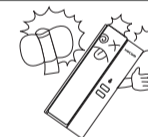

Do not drop Indoor or outdoor station, and avoid strong impact.

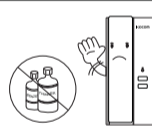

When cleaning, never use wet hands, volatile benzene or paint thinner.



Keep away from humidifier and stove. High temperature and humidity can cause malfunction

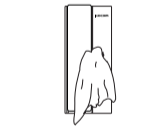

Maintain the product clean by frequently wiping outdoor with soft cloths

## Name of Each Part

### Indoor Station

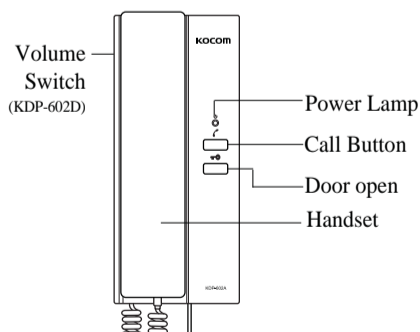

### Out door Station

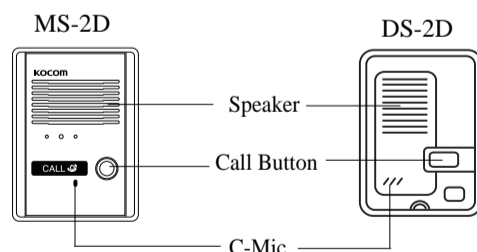

## Specifications

Description	KDP-602A
Electric source	AC110V or AC 220V (Saudi arabia) : AC 220V
Consumption	UN LOAD: 1.3W, IN LOAD: 4W (Saudi arabia) : 6W
Signal Sound	From door : chime , From indoor : Electronic Chime
Wiring	Door : 2Wired , Room : 6Wired
Range	KDP-602A ↔ KDP-602D = 30m KDP-602A or KDP-602D ↔ MS-2D or DS-2D = 50m

## Component

Master station for Indoor-use    Substation for Outdoor-use    Wall hanger for master station Doorlock

## Warranty



To receive after sales service, have the followings ready when you contact our branches

1. Name of the product
2. Model number of the product
3. The area of problem
4. Phone number and address at which you can be contacted.

## Warranty Card

PRODUCT	
MODEL	
DATE PURCHASED	
WARRANTY PERIOD	
AGENCY	
AGENCY ADDRESS	

© KOCOM Warranties the original purchaser of the product as follows.

- 1) This product is produced under strict quality control and inspection procedures.
- 2) If this product breaks down during proper use as a result of product defect, KOCOM will repair it within one year from date of purchase free of charge.
- 3) The following cases will be subject to charge, even during warranty period:
  - a. Breakdown during transport, or through careless treatment, by consumer.
  - b. Breakdown caused by unauthorized repair, or system modification.
  - c. Breakdown caused by natural disaster or power disorder.

## Wiring Diagram

### Wiring diagram of between two Indoor stations and DS-2D outdoor station

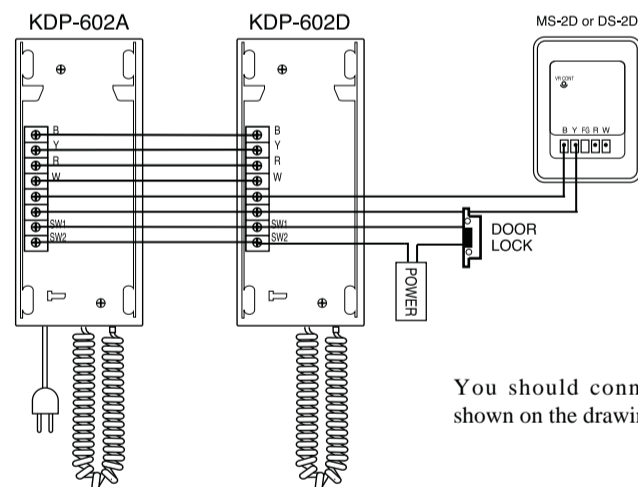

You should connect the wires as shown on the drawing

## Installation

### Installation of indoor station

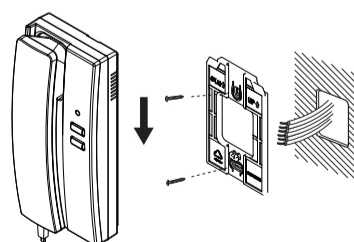

- A- Choose a place on the wall where you want to hang the DOOR PHONE.
- B- Fasten the wall hanger on the wall.
- C- DOOR PHONE can be hung on the wall hanger easily now.

### Installation of outdoor station

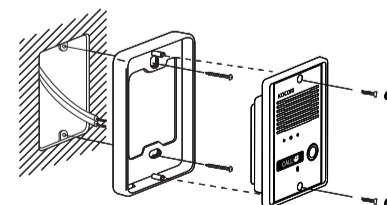

After attaching the body supporter with 2screws, put the Door Camera into the grooves of body supporter, and then fix it with screws.

Outdoor station can be attached on a wall or on a door as shown on the drawing.